

Description

The Arduino® Nano 33 IoT and Arduino Nano 33 IoT with headers are a miniature sized module containing a Cortex M0+ SAMD21 processor, a Wi-Fi® + Bluetooth® module based on ESP32, a crypto chip which can securely store certificates and pre-shared keys and a 6 axis IMU. The module can either be mounted as a DIP component (when mounting pin headers), or as a SMT component, directly soldering it via the castellated pads.

Target areas:

Maker, enhancements, basic IoT application scenarios



Features

- **SAMD21G18A**
 - **Processor**
 - 256 kB Flash
 - 32 kB Flash
 - Power On Reset (POR) and Brown Out Detection (BOD)
 - **Peripherals**
 - 12 channel DMA
 - 12 channel event system
 - 5x 16 bit Timer/Counter
 - 3x 24 bit timer/counter with extended functions
 - 32 bit RTC
 - Watchdog Time
 - CRC-32 generator
 - Full speed Host/Device USB with 8 end points
 - 6x SERCOM (USART, I²C, SPI, LIN)
 - Two channel I²S
 - 12 bit 350ksps ADC (up to 16 bit with oversampling)
 - 10 bit 350ksps DAC
 - External Interrupt Controller (up to 16 lines)

- **Nina W102**
 - **Module**
 - Dual Core Tensilica LX6 CPU at up to 240MHz
 - 448 kB ROM, 520 kB SRAM, 2MB Flash
 - **Wi-Fi®**
 - IEEE 802.11b up to 11Mbit
 - IEEE 802.11g up to 54MBit
 - IEEE 802.11n up to 72MBit
 - 2.4 GHz, 13 channels
 - -96 dBm sensitivity
 - **Bluetooth® BR/EDR**
 - Max 7 peripherals
 - 2.4 GHz, 79 channels
 - Up to 3 Mbit/s
 - 8 dBm output power at 2/3 Mbit/s
 - 11 dBm EIRP at 2/3 Mbit/s
 - -88 dBm sensitivity
 - **Bluetooth® Low Energy**
 - Bluetooth® 4.2 dual mode
 - 2.4GHz 40 channels
 - 6 dBm output power
 - 9 dBm EIRP
 - -88 dBm sensitivity
 - Up to 1 Mbit/
 - **MPM3610** (DC-DC)
 - Regulates input voltage from up to 21V with a minimum of 65% efficiency @minimum load
 - More than 85% efficiency @12V
 - **ATECC608A** (Crypto Chip)
 - Cryptographic co-processor with secure hardware based key storage
 - Protected storage for up to 16 keys, certificates or data
 - ECDH: FIPS SP800-56A Elliptic Curve Diffie-Hellman
 - NIST standard P256 elliptic curve support
 - SHA-256 & HMAC hash including off-chip context save/restore
 - AES-128 encrypt/decrypt, galois field multiply for GCM
 - **LSM6DSL** (6 axis IMU)
 - Always-on 3D accelerometer and 3D gyroscope
 - Smart FIFO up to 4 KByte based
 - $\pm 2/\pm 4/\pm 8/\pm 16$ g full scale
 - $\pm 125/\pm 250/\pm 500/\pm 1000/\pm 2000$ dps full scale

Contents

1 The Board	5
1.1 Application Examples	5
2 Ratings	5
2.1 Recommended Operating Conditions	5
2.2 Power Consumption	5
3 Functional Overview	5
3.1 Board Topology	5
3.2 Processor	7
3.3 Wi-Fi®/Bluetooth® Communication Module	7
3.4 Crypto	7
3.5 IMU	8
3.6 Power Tree	8
4 Board Operation	9
4.1 Getting Started - IDE	9
4.2 Getting Started - Arduino Cloud Editor	9
4.3 Getting Started - Arduino Cloud	9
4.4 Sample Sketches	9
4.5 Online Resources	9
4.6 Board Recovery	9
5 Connector Pinouts	10
5.1 USB	10
5.2 Headers	11
5.3 Debug	11
6 Mechanical Information	12
6.1 Board Outline and Mounting Holes	12
6.2 Connector Positions	12
7 Certifications	13
7.1 Declaration of Conformity CE DoC (EU)	13
7.2 Declaration of Conformity to EU RoHS & REACH 211 01/19/2021	13
7.3 Conflict Minerals Declaration	14
8 FCC Caution	14
9 Company Information	15
10 Reference Documentation	15
11 Revision History	15

1 The Board

As all Nano form factor boards, Nano 33 IoT and Nano 33 IoT with headers does not have a battery charger but can be powered through USB or headers.

NOTE: Nano 33 IoT and Nano 33 IoT with headers only supports 3.3V I/Os and is **NOT** 5V tolerant so please make sure you are not directly connecting 5V signals to this board or it will be damaged. Also, as opposed to Arduino Nano boards that support 5V operation, the 5V pin does NOT supply voltage but is rather connected, through a jumper, to the USB power input.

1.1 Application Examples

Weather station: Using the Nano 33 IoT or Nano 33 IoT with headers together with a sensor and a OLED display, we can create a small weather station communicating temperature, humidity etc. directly to your phone.

Air quality monitor: Bad air quality may have serious effects on your health. By assembling the board, with a sensor and monitor you can make sure that the air quality is kept in indoor-environments. By connecting the hardware assembly to an IoT application/API, you will receive real time values.

Air drum: A quick and fun project is to create a small air drum. Connect your board and upload your sketch from the Arduino Cloud Editor and start creating beats with your audio workstation of your choice.

2 Ratings

2.1 Recommended Operating Conditions

Symbol	Description	Min	Max
	Conservative thermal limits for the whole board:	-40 °C (40 °F)	85 °C (185 °F)

2.2 Power Consumption

Symbol	Description	Min	Typ	Max	Unit
VINMax	Maximum input voltage from VIN pad	-0.3	-	21	V
VUSBMax	Maximum input voltage from USB connector	-0.3	-	21	V
PMax	Maximum Power Consumption	-	-	TBC	mW

3 Functional Overview

3.1 Board Topology

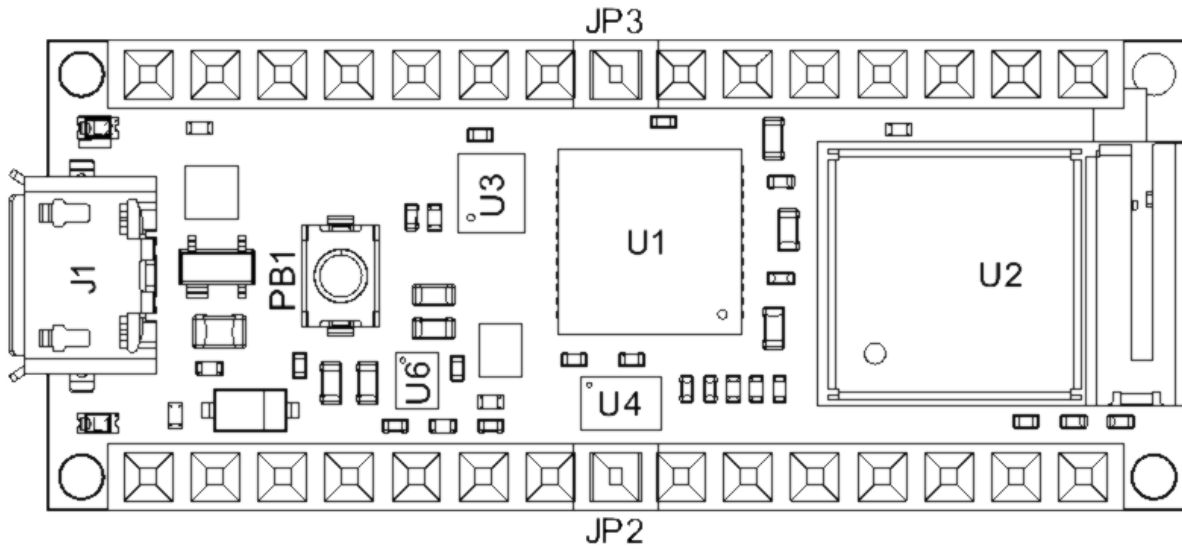

Board topology top

Ref.	Description	Ref.	Description
U1	ATSAMD21G18A Controller	U3	LSM6DSOXTR IMU Sensor
U2	NINA-W102-00B Wi-Fi®/Bluetooth® LE Module	U4	ATECC608A-MAHDA-T Crypto Chip
J1	Micro USB Connector	PB1	IT-1185-160G-GTR Push button

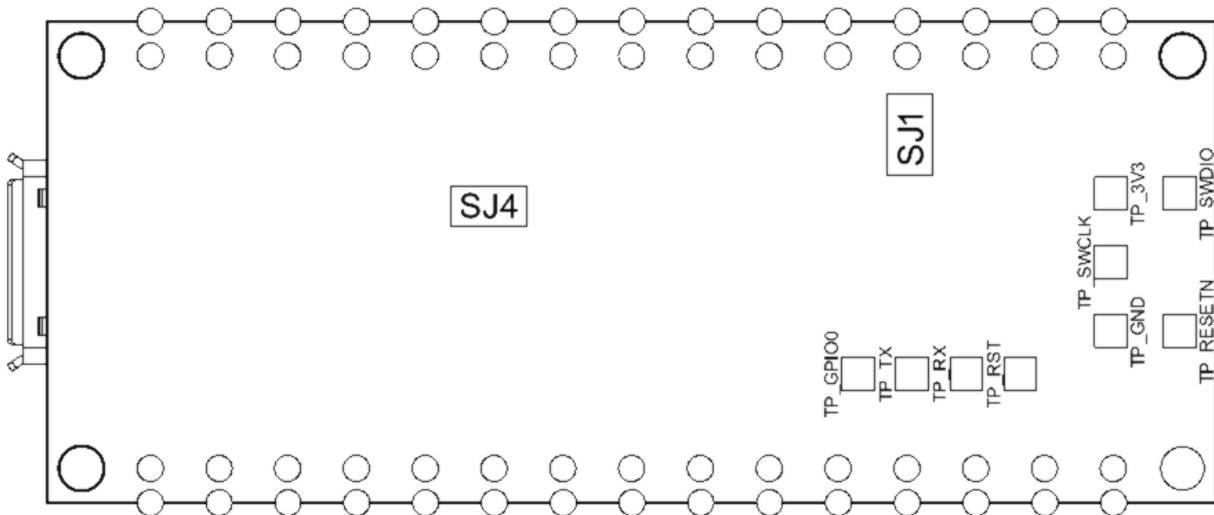

Board topology bottom

Ref.	Description	Ref.	Description
SJ1	Open solder bridge (VUSB)	SJ4	Closed solder bridge (+3V3)
TP	Test points	xx	Lorem Ipsum

3.2 Processor

The Main Processor is a Arm® Cortex®-M0+ running at up to 48 MHz. Most of its pins are connected to the external headers, however some are reserved for internal communication with the wireless module and the on-board internal I²C peripherals (IMU and Crypto).

NOTE: As opposed to other Arduino Nano boards, pins A4 and A5 have an internal pull up and default to be used as an I²C Bus so usage as analog inputs is not recommended.

Communication with NINA W102 happens through a serial port and a SPI bus through the following pins.

SAMD21 Pin	SAMD21 Acronym	NINA Pin	NINA Acronym	Description
13	PA08	19	RESET_N	Reset
39	PA27	27	GPIO0	Attention Request
41	PA28	7	GPIO33	Acknowledge
23	PA14	28	GPIO5	SPI CS
21	GPIO19	UART RTS		
24	PA15	29	GPIO18	SPI CLK
20	GPIO22	UART CTS		
22	PA13	1	GPIO23	SPI MISO
21	PA12	36	GPIO12	SPI MOSI
31	PA22	23	GPIO3	Processor TX ↔ Nina RX
32	PA23	22	GPIO1	Processor RX ↔ Nina TX

3.3 Wi-Fi®/Bluetooth® Communication Module

Nina W102 is based on ESP32 and is delivered with a pre-certified software stack from Arduino. Source code for the firmware is available [13].

NOTE: Reprogramming the wireless module's firmware with a custom one will invalidate compliance with radio standards as certified by Arduino, hence this is not recommended unless the application is used in private laboratories far from other electronic equipment and people. Usage of custom firmware on radio modules is the sole responsibility of the user.

Some of the module's pins are connected to the external headers and can be directly driven by ESP32 provided SAMD21's corresponding pins are aptly tri-stated. Below is a list of such signals:

SAMD21 Pin	SAMD21 Acronym	NINA Pin	NINA Acronym	Description
48	PB03	8	GPIO21	A7
14	PA09	5	GPIO32	A6
8	PB09	31	GPIO14	A5/SCL
7	PB08	35	GPIO13	A4/SDA

3.4 Crypto

The crypto chip in Arduino IoT boards is what makes the difference with other less secure boards as it provides a secure way to store secrets (such as certificates) and accelerates secure protocols while never exposing secrets in plain text.

Source code for the Arduino Library that supports the Crypto is available [14]

3.5 IMU

The board has an embedded 6-axis IMU which can be used to measure board orientation (by checking the gravity acceleration vector orientation) or to measure shocks, vibration, acceleration and rotation speed.

Source code for the Arduino Library that supports the IMU is available [\[15\]](#)

3.6 Power Tree

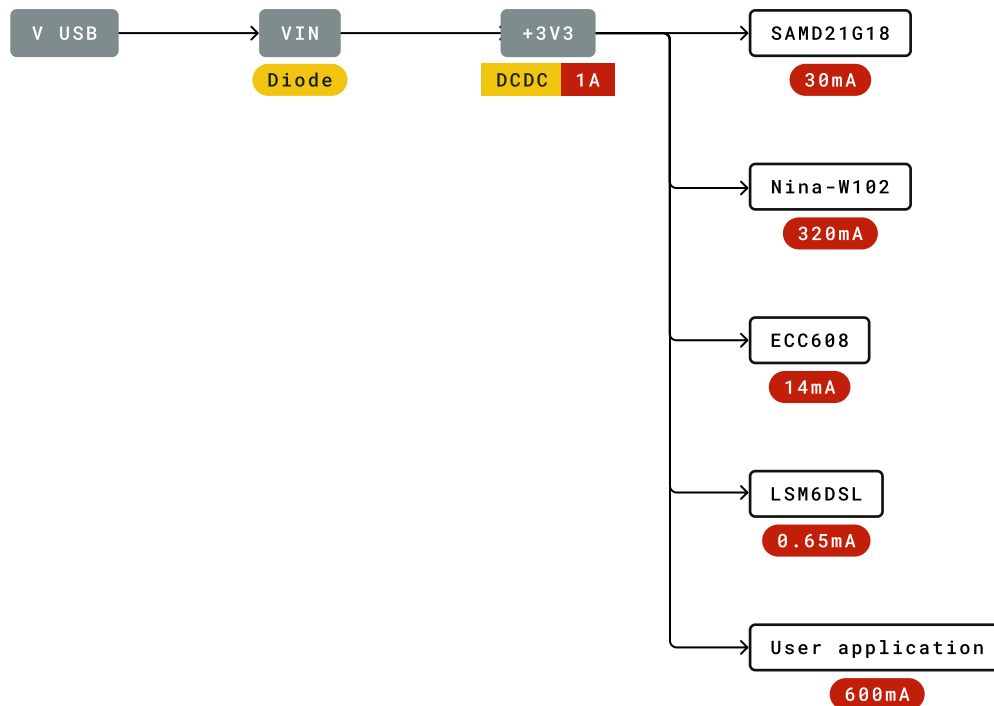

Legend:

- Component
- Power I/O
- Conversion Type
- Max Current
- Voltage Range

Power tree



4 Board Operation

4.1 Getting Started - IDE

If you want to program your board while offline you need to install the Arduino Desktop IDE [1] To connect the Nano 33 IoT to your computer, you'll need a Micro-B USB cable. This also provides power to the board, as indicated by the LED.

4.2 Getting Started - Arduino Cloud Editor

All Arduino boards, including this one, work out-of-the-box on the Arduino Cloud Editor [2], by just installing a simple plugin.

The Arduino Cloud Editor is hosted online, therefore it will always be up-to-date with the latest features and support for all boards. Follow [3] to start coding on the browser and upload your sketches onto your board.

4.3 Getting Started - Arduino Cloud

All Arduino IoT enabled products are supported on Arduino Cloud which allows you to Log, graph and analyze sensor data, trigger events, and automate your home or business.

4.4 Sample Sketches

Sample sketches for the Nano 33 IoT can be found either in the "Examples" menu in the Arduino IDE or in the "Documentation" section of the Arduino Docs website [4].

4.5 Online Resources

Now that you have gone through the basics of what you can do with the board you can explore the endless possibilities it provides by checking exciting projects on Arduino Project Hub [5], the Arduino Library Reference [6] and the online store [7] where you will be able to complement your board with sensors, actuators and more

4.6 Board Recovery

All Arduino boards have a built-in bootloader which allows flashing the board via USB. In case a sketch locks up the processor and the board is not reachable anymore via USB it is possible to enter bootloader mode by double-tapping the reset button right after power up.

5 Connector Pinouts



ARDUINO NANO 33 IoT

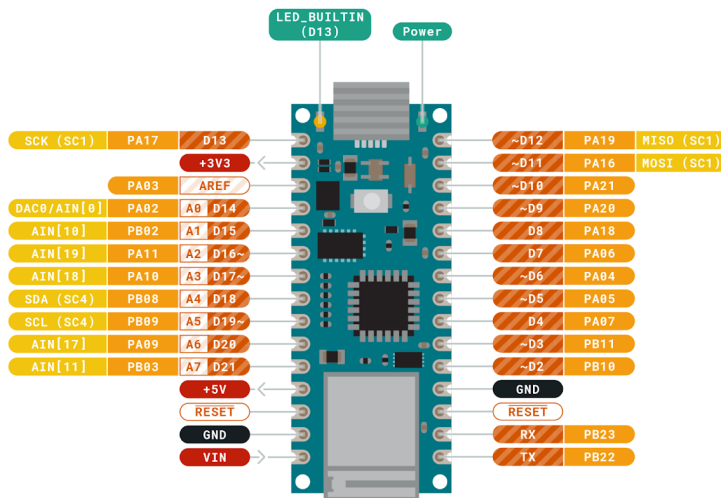

Ground	Internal Pin	Digital Pin	Microcontroller's Port
Power	SWD Pin	Analog Pin	
LED	Other Pin	Default	

ARDUINO.CC
CC BY SA
This work is licensed under the Creative Commons Attribution-ShareAlike 4.0 International License. To view a copy of this license, visit <http://creativecommons.org/licenses/by-sa/4.0/> or send a letter to Creative Commons, PO Box 1866, Mountain View, CA 94042, USA.

Pinout

5.1 USB

Pin	Function	Type	Description
1	VUSB	Power	Power Supply Input. If board is powered via VUSB from header this is an Output (1)
2	D-	Differential	USB differential data -
3	D+	Differential	USB differential data +
4	ID	Analog	Selects Host/Device functionality
5	GND	Power	Power Ground

1. The board can support USB host mode only if powered via the V_{USB} pin and if the jumper close to the VUSB pin is shorted.

5.2 Headers

The board exposes two 15 pin connectors which can either be assembled with pin headers or soldered through castellated vias.

Pin	Function	Type	Description
1	D13	Digital	GPIO
2	+3V3	Power Out	Internally generated power output to external devices
3	AREF	Analog	Analog Reference; can be used as GPIO
4	A0/DAC0	Analog	ADC in/DAC out; can be used as GPIO
5	A1	Analog	ADC in; can be used as GPIO
6	A2	Analog	ADC in; can be used as GPIO
7	A3	Analog	ADC in; can be used as GPIO
8	A4/SDA	Analog	ADC in; I2C SDA; Can be used as GPIO (1)
9	A5/SCL	Analog	ADC in; I2C SCL; Can be used as GPIO (1)
10	A6	Analog	ADC in; can be used as GPIO
11	A7	Analog	ADC in; can be used as GPIO
12	VUSB	Power In/Out	Normally NC; can be connected to VUSB pin of the USB connector by shorting a jumper
13	RST	Digital In	Active low reset input (duplicate of pin 18)
14	GND	Power	Power Ground
15	VIN	Power In	Vin Power input
16	TX	Digital	USART TX; can be used as GPIO
17	RX	Digital	USART RX; can be used as GPIO
18	RST	Digital	Active low reset input (duplicate of pin 13)
19	GND	Power	Power Ground
20	D2	Digital	GPIO
21	D3/PWM	Digital	GPIO; can be used as PWM
22	D4	Digital	GPIO
23	D5/PWM	Digital	GPIO; can be used as PWM
24	D6/PWM	Digital	GPIO, can be used as PWM
25	D7	Digital	GPIO
26	D8	Digital	GPIO
27	D9/PWM	Digital	GPIO; can be used as PWM
28	D10/PWM	Digital	GPIO; can be used as PWM
29	D11/MOSI	Digital	SPI MOSI; can be used as GPIO
30	D12/MISO	Digital	SPI MISO; can be used as GPIO

5.3 Debug

On the bottom side of the board, under the communication module, debug signals are arranged as 3x2 test pads with 100 mil pitch. Pin 1 is depicted in Figure 3 – Connector Positions

Pin	Function	Type	Description
1	+3V3	Power Out	Internally generated power output to be used as voltage reference
2	SWD	Digital	SAMD11 Single Wire Debug Data
3	SWCLK	Digital In	SAMD11 Single Wire Debug Clock
4	UPDI	Digital	ATMega4809 update interface
5	GND	Power	Power Ground
6	RST	Digital In	Active low reset input

6 Mechanical Information

6.1 Board Outline and Mounting Holes

The board measures are mixed between metric and imperial. Imperial measures are used to maintain a 100 mil pitch grid between pin rows to allow them to fit a breadboard whereas board length is Metric.

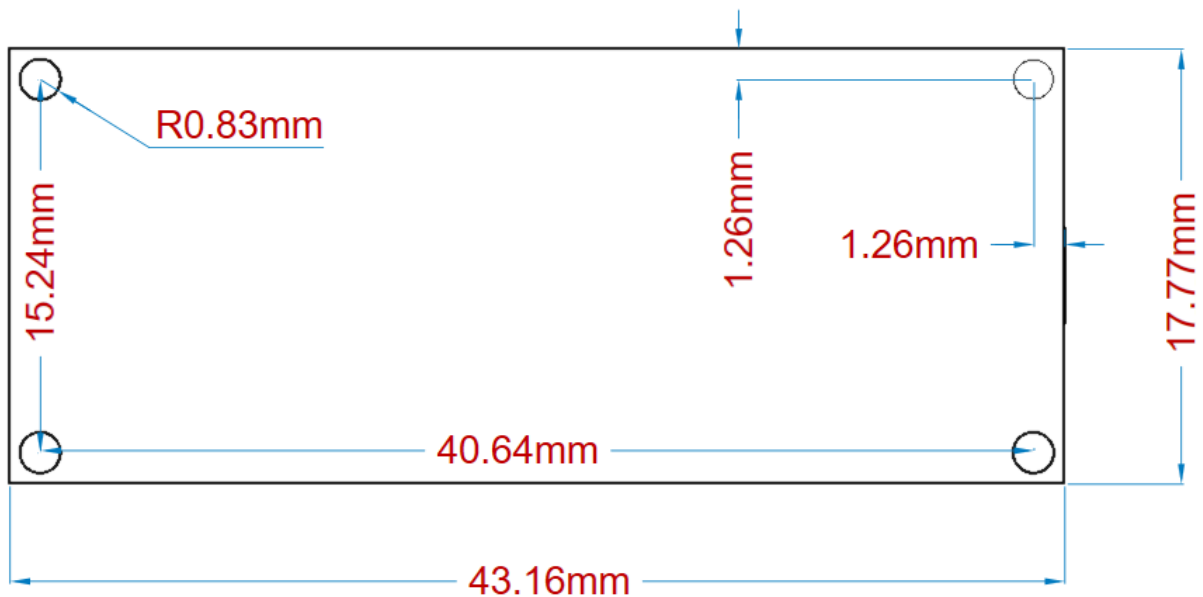

Layout

6.2 Connector Positions

The view below is from top however it shows Debug connector pads which are on the bottom side. Highlighted pins are pin 1 for each connector'

Top view:

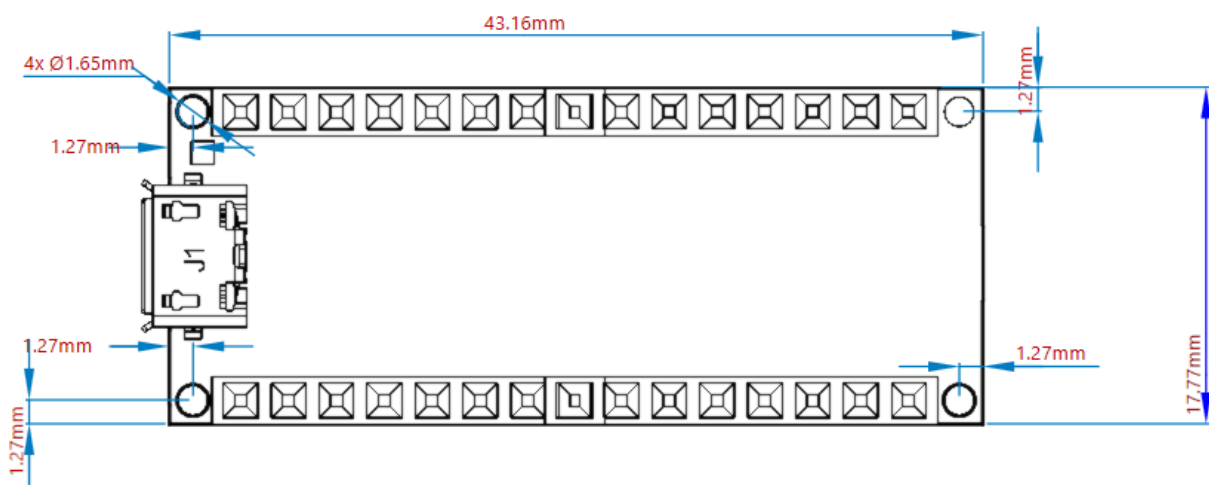

Top side connectors

Bottom view:

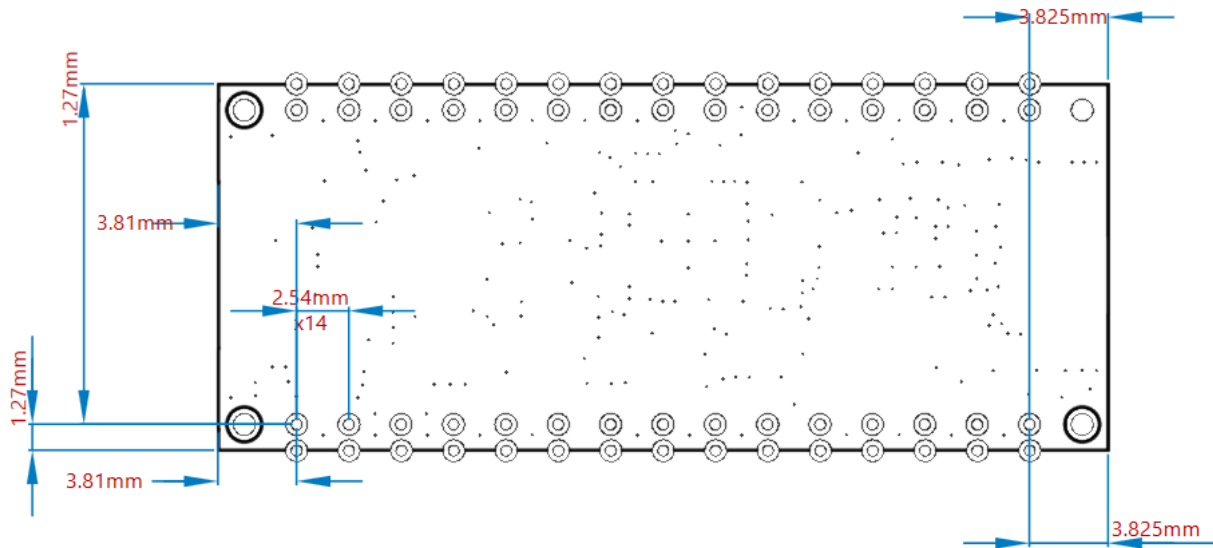

Bottom side connectors

7 Certifications

7.1 Declaration of Conformity CE DoC (EU)

We declare under our sole responsibility that the products above are in conformity with the essential requirements of the following EU Directives and therefore qualify for free movement within markets comprising the European Union (EU) and European Economic Area (EEA).

7.2 Declaration of Conformity to EU RoHS & REACH 211 01/19/2021

Arduino boards are in compliance with RoHS 2 Directive 2011/65/EU of the European Parliament and RoHS 3 Directive 2015/863/EU of the Council of 4 June 2015 on the restriction of the use of certain hazardous substances in electrical and electronic equipment.

Substance	Maximum limit (ppm)
Lead (Pb)	1000
Cadmium (Cd)	100
Mercury (Hg)	1000
Hexavalent Chromium (Cr6+)	1000
Poly Brominated Biphenyls (PBB)	1000
Poly Brominated Diphenyl ethers (PBDE)	1000
Bis(2-Ethylhexyl} phthalate (DEHP)	1000
Benzyl butyl phthalate (BBP)	1000
Dibutyl phthalate (DBP)	1000
Diisobutyl phthalate (DIBP)	1000

Exemptions : No exemptions are claimed.

Arduino Boards are fully compliant with the related requirements of European Union Regulation (EC) 1907 /2006 concerning the Registration, Evaluation, Authorization and Restriction of Chemicals (REACH). We declare none of the SVHCs (<https://echa.europa.eu/web/guest/candidate-list-table>), the Candidate List of Substances of Very High Concern for authorization currently released by ECHA, is present in all products (and also package) in quantities totaling in a concentration equal or above 0.1%. To the best of our knowledge, we also declare that our products do not contain any of the substances listed on the "Authorization List" (Annex XIV of the REACH regulations) and Substances of Very High Concern (SVHC) in any significant amounts as specified by the Annex XVII of Candidate list published by ECHA (European Chemical Agency) 1907 /2006/EC.

7.3 Conflict Minerals Declaration

As a global supplier of electronic and electrical components, Arduino is aware of our obligations with regards to laws and regulations regarding Conflict Minerals, specifically the Dodd-Frank Wall Street Reform and Consumer Protection Act, Section 1502. Arduino does not directly source or process conflict minerals such as Tin, Tantalum, Tungsten, or Gold. Conflict minerals are contained in our products in the form of solder, or as a component in metal alloys. As part of our reasonable due diligence Arduino has contacted component suppliers within our supply chain to verify their continued compliance with the regulations. Based on the information received thus far we declare that our products contain Conflict Minerals sourced from conflict-free areas.

8 FCC Caution

Any Changes or modifications not expressly approved by the party responsible for compliance could void the user's authority to operate the equipment.

This device complies with part 15 of the FCC Rules. Operation is subject to the following two conditions:

- (1) This device may not cause harmful interference
- (2) this device must accept any interference received, including interference that may cause undesired operation.

FCC RF Radiation Exposure Statement:

1. This Transmitter must not be co-located or operating in conjunction with any other antenna or transmitter.
2. This equipment complies with RF radiation exposure limits set forth for an uncontrolled environment.
3. This equipment should be installed and operated with minimum distance 20cm between the radiator & your body.

English: User manuals for license-exempt radio apparatus shall contain the following or equivalent notice in a conspicuous location in the user manual or alternatively on the device or both. This device complies with Industry Canada license-exempt RSS standard(s). Operation is subject to the following two conditions:

- (1) this device may not cause interference
- (2) this device must accept any interference, including interference that may cause undesired operation of the device.

French: Le présent appareil est conforme aux CNR d'Industrie Canada applicables aux appareils radio exempts de licence. L'exploitation est autorisée aux deux conditions suivantes :

- (1) l'appareil n' doit pas produire de brouillage
- (2) l'utilisateur de l'appareil doit accepter tout brouillage radioélectrique subi, même si le brouillage est susceptible d'en compromettre le fonctionnement.

IC SAR Warning:

English This equipment should be installed and operated with minimum distance 20 cm between the radiator and your body.

French: Lors de l' installation et de l' exploitation de ce dispositif, la distance entre le radiateur et le corps est d' au moins 20 cm.

Important: The operating temperature of the EUT can't exceed 85°C and shouldn't be lower than -40°C.

Hereby, Arduino S.r.l. declares that this product is in compliance with essential requirements and other relevant provisions of Directive 2014/53/EU. This product is allowed to be used in all EU member states.

Frequency bands	Maximum output power (EIRP)
2402-2480MHz(EDR)	6.24 dBm
2402-2480MHz(BLE)	6.30 dBm
2412-2472MHz(2.4G WiFi)	13.61 dBm



9 Company Information

Company name	Arduino S.r.l
Company Address	Via Andrea Appiani,2520900 MONZA

10 Reference Documentation

Reference	Link
Arduino IDE (Desktop)	https://www.arduino.cc/en/software
Arduino Cloud Editor	https://create.arduino.cc/editor
Arduino Cloud Editor - Getting Started	https://docs.arduino.cc/arduino-cloud/guides/editor/
Arduino Documentation	https://docs.arduino.cc
Arduino Project Hub	https://create.arduino.cc/projecthub?by=part&part_id=11332&sort=trending
Library Reference	https://www.arduino.cc/reference/en/
Arduino Store	https://store.arduino.cc/
Forum	http://forum.arduino.cc/
SAMD21G18	https://ww1.microchip.com/downloads/aemDocuments/documents/MCU32/ProductDocuments/DataSheets/SAM-D21DA1-Family-Data-Sheet-DS40001882G.pdf
NINA W102	https://content.u-blox.com/sites/default/files/NINA-W10_DataSheet_UBX-17065507.pdf
ECC608	https://ww1.microchip.com/downloads/aemDocuments/documents/SCBU/ProductDocuments/DataSheets/ATECC608A-CryptoAuthentication-Device-Summary-Data-Sheet-DS40001977B.pdf
MPM3610	https://www.monolithicpower.com/pub/media/document/MPM3610_r1.01.pdf
NINA Firmware	https://github.com/arduino/nina-fw
ECC608 Library	https://github.com/arduino-libraries/ArduinoECCX08
LSM6DSL Library	https://github.com/stm32duino/LSM6DSL

11 Revision History

Date	Revision	Changes
25/04/2024	4	Updated link to new Cloud Editor
27/10/2023	3	Correction NINA SPI pins
03/08/2022	2	Reference documentation links updates
15/04/2021	1	General datasheet updates